

ALBANY SHED CO
FLOOR PLAN: 1004 LAUGHTON 3.0 x 1.2m approx.

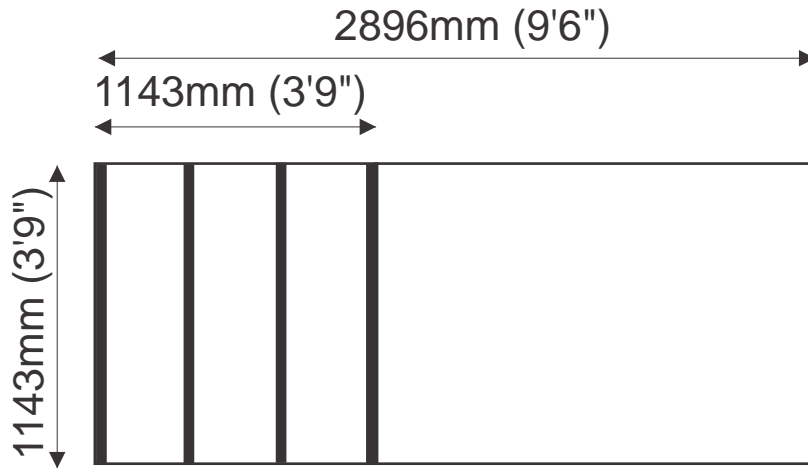

We reserve the right to alter design without prior notice